

0 603 367 003

Stand } ~~00-03~~
Issue } 01-06-18

Fig./Abb. 1

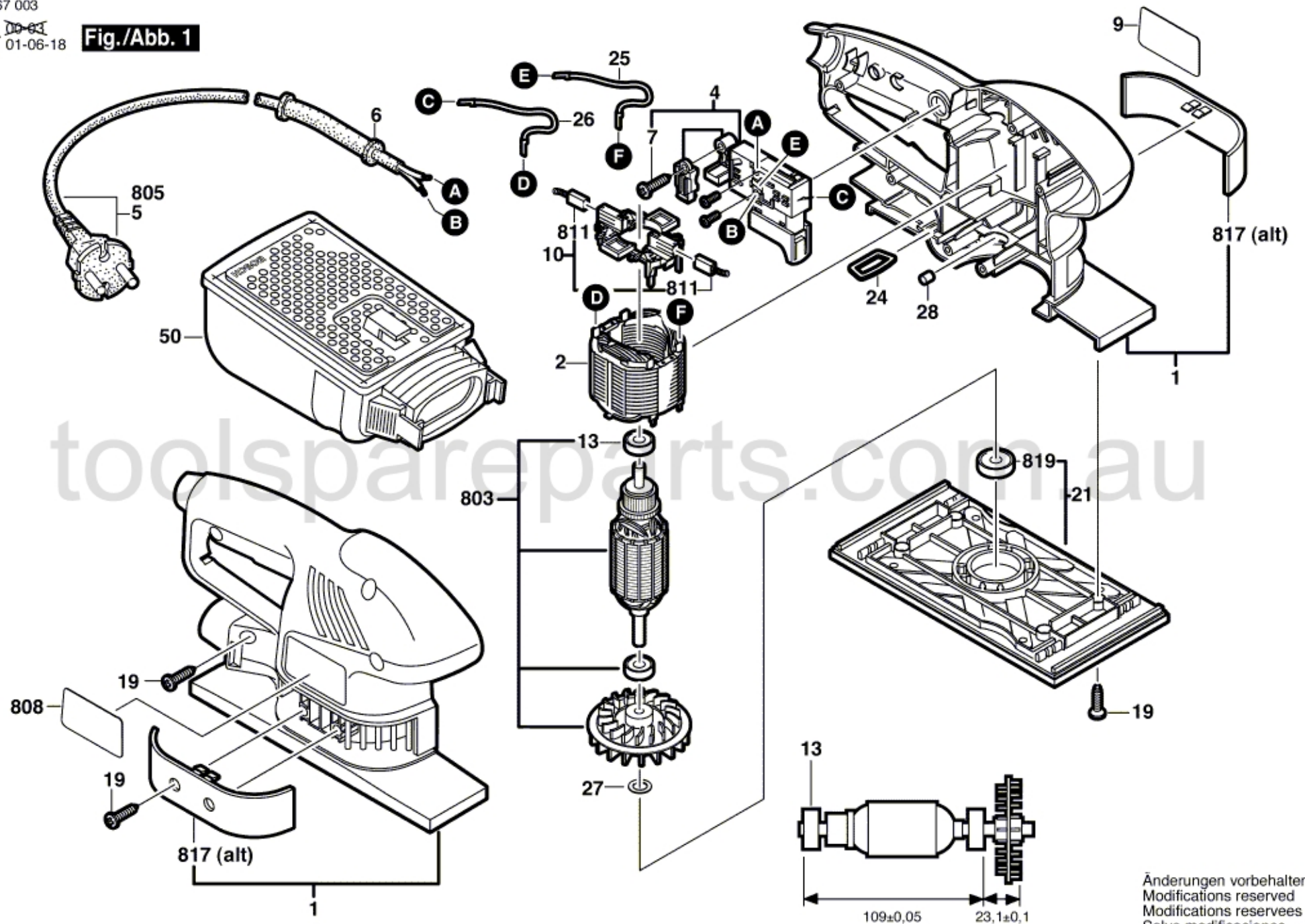

Änderungen vorbehalten
Modifications reserved
Modificaciones reservadas
Salvo modificaciones